

CELLUON

# LASERKEY CL800BT

PROJECTION KEYBOARD

User Manual



Bluetooth®

## **Safety Precautions**

- Avoid long time expose to the direct light or heat.
- Faults may occur if kept in extreme of temperatures.
- May become damaged if dropped or knocked.
- Problems may occur if exposed to humid and/or dusty conditions.
- Do not use if power cable or plug are damaged.
- Use only dedicated cable/adapter.
- Do not disassemble.
- Do not look directly at the light source, as this can cause damage to the eye.

## **Regulatory Information**

### **FCC compliance Information**

This device complies with part 15 of FCC Rules.

Operation is subject to the following two conditions:

1. This device may not cause harmful interference.
2. This device must accept any interference received, including interference that may cause undesired operation.

### **Information to User**

This equipment has been tested and found to comply with the limits for a Class B digital device, Pursuant to part 15 of the FCC Rules. These limits are designed to provide reasonable protection against harmful interference in a residential installation.

This equipment generates, uses and can radiate radio Frequency energy and, if not installed and used in accordance with the instructions, may cause harmful interference to radio communications. However, there is no guarantee that interference will not occur in a particular installation. If this equipment does cause harmful interference to radio or television reception, which can be determined by turning the equipment off and on, the user is encouraged to try to correct the interference by one or more of the following measures:

- Redirect or reposition the receiving antenna
- Increase the separation between the equipment and receiver
- Connect the equipment to a socket on a circuit different from that to which the receiver is connected.
- Consult the dealer or an experienced radio/TV technician for help.

**FCC WARNING:** This equipment may generate or use radio-frequency energy. Changes or modifications to this equipment may cause harmful interference, unless such modifications are expressly approved in the instruction manual. The user's license to operate this equipment may be revoked if an unauthorized change or modification is made.

**RF Exposure Information:** The antenna used for this transmitter must be installed at a distance of at least 20 cm from all persons and must not be co-located or operated in conjunction with any other antenna or transmitter.

**CE :**

EN300328  
EN301489  
EN60950

## Laser Safety:

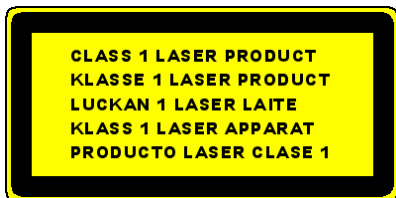

## Environmental Notice

This product does not any materials specified harmful to the human body. At the end of this product's service life, please separate with the life waste and discharge or go to the Celluon service center for environmental protection.



## Battery Information

**Battery service life: 220 minutes continuous use (max)**

**Capacity: 830mAh (max) @ 3.7V**

### Charging the Battery

**Use the adapter supplied for connection to the power supply. The battery will now start charging.**

**Charging time: 150 min**



### Caution

- Use of any other adapter may cause the battery to explode.
  - After purchasing the product, charge the battery before use.
  - Charging time is dependent on ambient temperature i.e. it may be longer or shorter in extreme heat or cold.
  - It is possible that the battery is not fully charged even when the charging indicator is illuminated.
  - Since battery belongs to expendable supplies, service life gradually shortens after several uses.
-

## Table Contents

<b>1. FEATURES.....</b>	<b>9</b>
<b>2. COMPONENTS .....</b>	<b>10</b>
<b>3. PARTS AND THEIR FUNCTIONS .....</b>	<b>11</b>
3.1 FRONT.....	11
3.2 REAR.....	12
3.3 TOP.....	13
<b>4. HOW TO OPERATE.....</b>	<b>14</b>
4.1 INSTALLATION.....	14
4.2 IN BLUETOOTH MODE.....	15
<b>5. HOW TO INSTALL, REMOVE AND USE SOFTWARE.....</b>	<b>15</b>
5.1 POCKET PC .....	15
5.1.1 System Requirements .....	15
5.1.2 Installation/Upgrading/Uninstalling the Driver .....	15
5.1.3 Connection Method.....	18
5.1.4 Disabling the Projection Keyboard Sound .....	22
5.1.5 PK Settings Application.....	23
5.1.6 Tutorial .....	33
5.1.7 Shortcut Icon Keys.....	34
5.1.8 Function Key and Ctrl Key .....	35

5.2 PALM OS.....	36
5.2.1 System Requirements .....	36
5.2.2 Installation/Upgrading/Uninstalling.....	36
5.2.4 PK Settings .....	44
5.2.5 PK Tutorial .....	49
5.2.6 Shortcut Icon Keys.....	52
5.2.7 Shortcut Keys .....	53
<b>6. KEYBOARD LAYOUT.....</b>	<b>55</b>
<b>7. TYPING LATIN LETTERS AND ADDITIONAL CHARACTERS .55</b>	
<b>8. ADJUSTING KEY SENSITIVITY.....</b>	<b>58</b>
<b>9. SAFETY PRECAUTIONS .....</b>	<b>60</b>
<b>10. TROUBLESHOOTING .....</b>	<b>62</b>
<b>11. SPECIFICATIONS AND DEMENSIONS .....</b>	<b>64</b>



## 1. Features



**Uses normal QWERTY keyboard layout.**

**Compact size (convenient to carry).**

**Includes function and shortcut icon keys.**

**Robust and durable, uses optical technologies**

**Bluetooth and serial port interface connections.**

**Rapid entry keys.**

**Economical, uses an integrated, rechargeable lithium battery.**

**Compatible with Pocket PC, Palm OS and Windows.**

## 2. Components



Laserkey



Installation CD



Case



Quick Install Guide



Adapter

Serial cable is optional. (refer to <http://www.celluon.com>.)

### CDs:

- CL800BT Manual
- Palm Driver Installation File
- Pocket PC 2003 Driver (Widcomm Bluetooth Stack) Installation File)
- Pocket PC 2003 Driver (Microsoft Bluetooth Stack) Installation File)

## 3. Parts and their Functions

### 3.1 Front

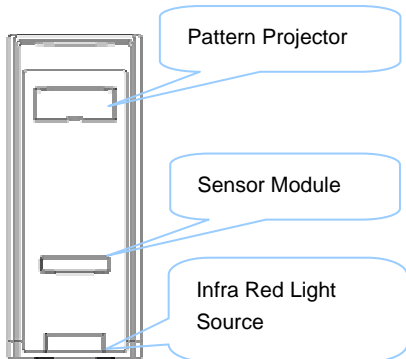

**Projector:** projects the keyboard image.

**Infra Red Light Source:** supplies the light source to allow the **Sensor Module** to recognize key strokes.

**Sensor Module:** recognizes key strokes and transmits them to the processing device.

### 3.2 Rear

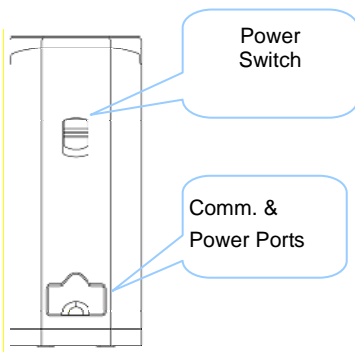

#### **POWER**

**UP / DOWN → ON / OFF Switch**

**Communication & Power Ports**

**Serial Port RC232C Cable**

**Power Port 1A @ 5V adaptor**



Only use the cable / adaptor supplied.

### 3.3 Top

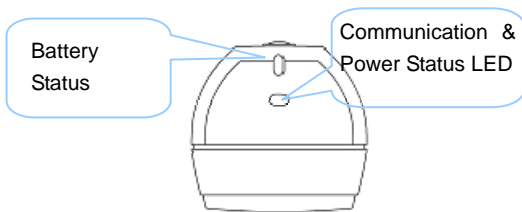

#### **Battery Status LED**

- **Charging → Red**
- **Fully Charged → Green**
- **Battery Power Low → Orange**
- **(Power off within 5 minutes.)**

#### **Communication & Power Status LED**

- **Bluetooth Mode**  
**Pairing : Blue flashing**  
**Link: Blue**
- **Serial Mode**  
**LED Green**

### **\* What is Bluetooth?**

Standard wireless communication between wireless communication devices using low power and over short distances.

---

#### **Note:**

When you want to exit from using Pocket PC and CL800BT with Bluetooth communication setting, exit by using Pocket PC own keyboard. (Due to operating error, it may reset Pocket PC).

---

## **4. How to Operate**

### **4.1 Installation**

1. Install software as described in "Manual 5".
2. Turn power on.
3. Connect device to computer via cable.
4. Run program as described in "Manual 5" for environment setup.
5. Use laser keyboard.

## **4.2 In Bluetooth Mode**

1. Install software as described in “Manual 5”.
2. Turn power on.
3. Set up Bluetooth environment as described in “Manual 5”.
4. Use laser keyboard.

## **5. How to install, remove and use software**

### **5.1 Pocket PC**

#### **5.1.1 System Requirements**

1. Microsoft Windows 2000/XP operating system.
2. Microsoft ActiveSync 3.6 or above.
3. Pocket PC based on Microsoft Windows Mobile 2003, with Bluetooth (Widcomm or Microsoft).

#### **5.1.2 Installation/ Upgrading/ Uninstalling the Driver**

For serial port drivers please refer to <http://www.celluon.com>.

## 1. Installation

- 1) Connect PC to Pocket PC via ActiveSync.
- 2) Insert installation CD into the CD-ROM drive of your PC to start the installation program.
- 3) Follow installation program instructions.

## 2. Upgrading

Download and install a new driver from <http://www.celluon.com>.

## 3. Uninstalling

- 1) Select **Today** → **Settings** → **System** → **Remove Programs** as shown in Figure 1.



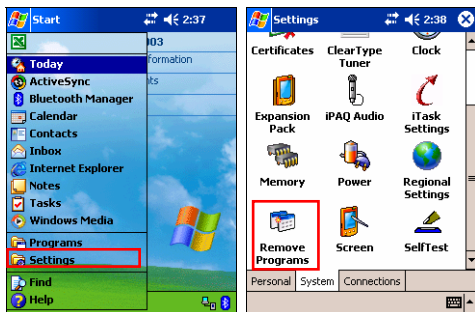

Figure 1. Uninstalling the Driver

2) Choose **Projection Keyboard** and click **Remove**, as shown in Figure 2. Follow the on-screen instructions.

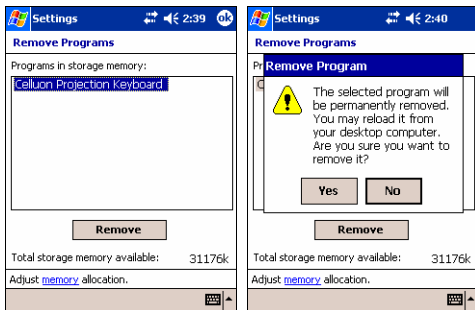

Figure 2. Uninstalling the Driver

### 5.1.3 Connection Method

To connect a Pocket PC to the Projection Keyboard follow the instructions below.

1. Turn on power to Pocket PC and Projection Keyboard.

---

Note: Verify that sufficient battery power is supplied to the Projection Keyboard device

---

2. Run the program required to enter the keyboard as shown in Figure 3 (e.g. Note).

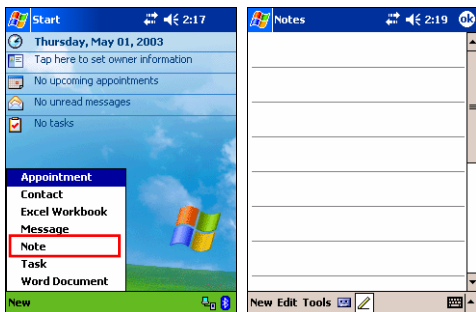

**Figure 3. Running the Program**

3. Select **Projection Keyboard** from the options, as shown in Figure 4.

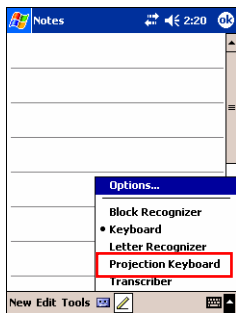

**Figure 4. Selecting a Device**

4. When the Bluetooth Browser is open, choose CL800BT, as shown in Figure 5.

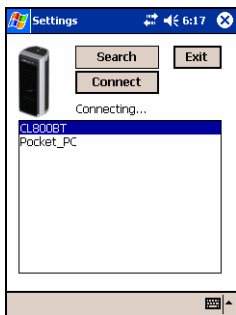

**Figure 5. Selecting a Bluetooth Device**

5. You are now ready to use the Projection Keyboard. To change the Projection Keyboard's set values, click on the Projection Keyboard icon to view the control panel, as shown in Figure 6.

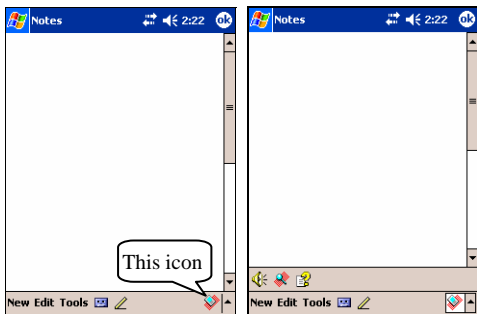

**Figure 6. Projection Keyboard Control Panel**

### 5.1.4 Disabling the Projection Keyboard Sound

When the user clicks the keyboard sound icon, a clicking sound is emitted from the Pocket PC. To turn off the sound, click the keyboard sound button once; click again to turn it back on, as shown in Figure 7.

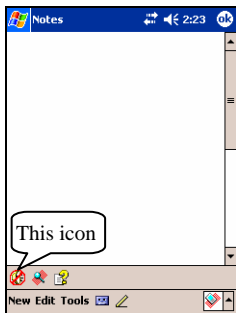

**Figure 7. Keyboard Sound Icon**

### 5.1.5 PK Settings Application

Click on the settings icon to change the different setting values on the Projection Keyboard, as shown in Figure 8.

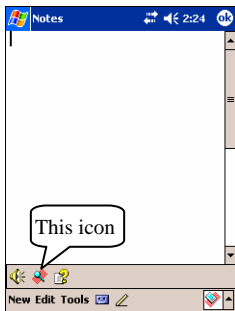

**Figure 8. PK Settings Icon**

Click the settings icon to view the Change Settings screen, as shown in Figure 9. These settings enable the user to adjust key repeat, key sound and key sensitivity.

### 5.1.5.1 Main Change Settings Tab

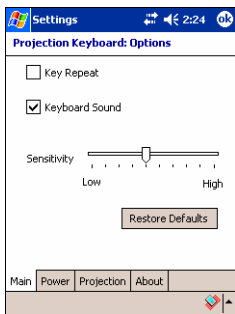

**Figure 9. Main Change Settings Tab**

#### **Key Repeat**

By using Key Repeat, continuously pressing a key causes the value to be entered repeatedly. Select the **Key Repeat** checkbox to use the key repeat function or deselect to disable the function.



## **Keyboard Sound**

Clicking the Keyboard Sound function causes a clicking sound to be emitted from the Pocket PC. Select the Keyboard Sound checkbox to turn on the key sound function or deselect it to disable the function.

## **Sensitivity**

If the Projection Keyboard has a problem with key sensitivity, adjust the setting using the slider.

For details, see “8. Adjusting Key Sensitivity”.

## **Restoring Defaults**

To restore all functions to their default values, click the Restore Defaults button.

### 5.1.5.2 Power Save Mode

Adjust the Power Save Mode from the **Power** tab on the Change Settings screen.

#### Power Save Mode On

Click on the **Power Save Mode On** checkbox to use this function, as shown in Figure 10.

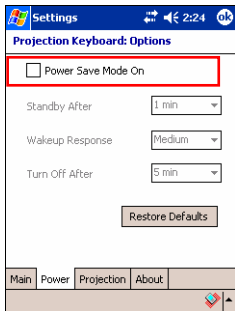

**Figure 10. Power Save Mode**

## Standby

Change the Standby setting value to alter the time elapsed before the system enters Standby mode. In Standby mode, if no keys are pressed within a given period of time the device will enter a low power mode until a key is pressed again.

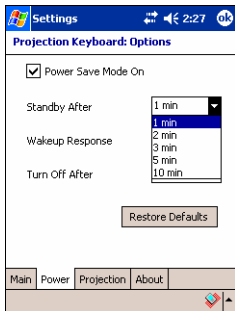

**Figure 11. Standby Mode**

## Wakeup Response

To use the keyboard again, press any key or area of the keyboard. Change the Wakeup Response settings to adjust the speed for switching between Standby and normal mode, as shown in Figure 12.

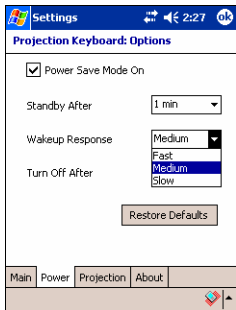

**Figure 12. Wakeup Response**

## Turning Off the Projection Keyboard

Once in Standby mode, if no keys are pressed within the time specified in the Turn Off After field, the device will enter Power OFF mode, as shown in Figure 13. To use the keyboard from Power OFF mode, turn the Projection Keyboard on again.

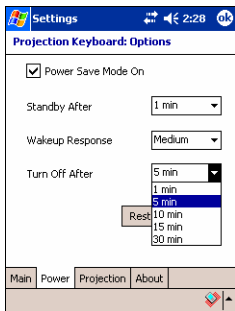

Figure 13. Power OFF Mode Time Setting

## Restoring Defaults

To restore the settings in the Power tab to their default values, click the **Restore Defaults** button.

### 5.1.5.3 Projection Control

Adjust keyboard brightness using the settings in the **Projection** tab.

#### Projector Normal

Adjust the keyboard brightness using the slider for the Projector Normal setting, as shown in Figure 14

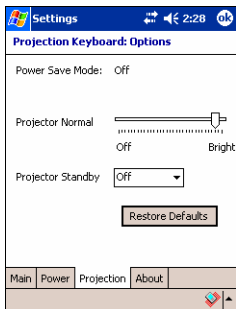

**Figure 14. Projector Normal**

## Projector Standby Mode

Change the settings in the Projector Standby box to set the keyboard brightness in Standby mode, as shown in Figure 15.

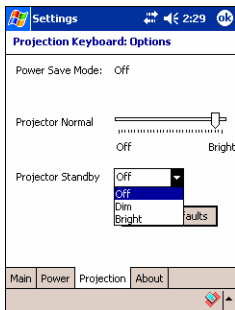

**Figure 15. Projector Standby**

## Restoring Defaults

To restore the settings in the Power tab to their default values, click the **Restore Defaults** button.

#### 5.1.5.4 Driver Information

Driver information for the Projection Keyboard is located under the About tab in the Settings screen, as shown in Figure 16.

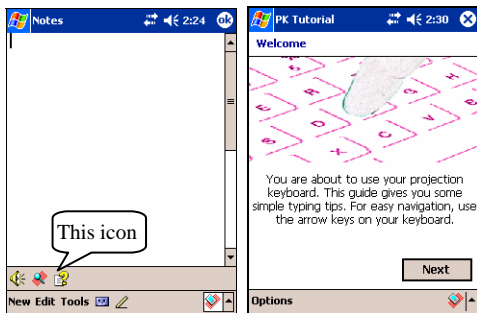

**Figure 16. Driver Information**



## 5.1.6 Tutorial









Click the Tutorial icon in the Projection Keyboard control panel to launch the Projection Keyboard Tutorial, as shown in Figure 17. The Tutorial offers information on how to use the Projection Keyboard.



**Figure 17. Projection Keyboard Tutorial**

### 5.1.7 Shortcut Icon Keys

Table 1.1 below shows the description for each icon.

Icon	Functions
	Switch to <b>Today</b> screen
	Run <b>To Do</b> program
	Run <b>Mail</b> program
	Run <b>Find</b> program
	Run <b>Web Browser</b>
	Run <b>Calculator</b> program
	Run <b>Calendar</b> program
	Run <b>Address</b> program

**Table 1.1 Shortcut Icon Keys**

## 5.1.8 Function Key and Ctrl Key

Table 1.2 shows FN and CTRL key combinations.

Key	Shortcut Key	Functions
<b>FN</b>	FN - 1	Run <b>Note</b> program
	FN - ENTER	Close the current program
	FN - ← (Left Arrow)	<b>Home</b>
	FN - → (Right Arrow)	<b>End</b>
	FN - ↑ (Up arrow)	<b>Page Up</b>
	FN - ↓ (Down Arrow)	<b>Page Down</b>
<b>CTRL</b>	CTRL - Z	<b>Undo</b>
	CTRL - X	<b>Cut</b>
	CTRL - V	<b>Paste</b>
	CTRL - C	<b>Copy</b>
	CTRL - A	<b>Select All</b>
	CTRL - U	<b>Underline</b>
	CTRL - N	<b>Application Specific</b>
	CTRL - S	<b>Application Specific</b>
	CTRL - F	<b>Application Specific</b>
	CTRL - Q	<b>Application Specific</b>

**Table 1.2 Key Combinations**

## **5.2 Palm OS**

### **5.2.1 System Requirements**

1. Microsoft Windows 2000/XP operating system.
2. HotSync software.
3. Palm OS 5 or later.

### **5.2.2 Installation/ Upgrading/Uninstalling**

For the serial port driver, please refer to <http://www.celluon.com>

#### **Installation**

1. Insert CD into the CD-ROM drive of the PC to run the installation program.
2. Follow the on-screen instructions to install the program.

#### **Upgrading**

Find out above new drivers by referring to <http://www.celluon.com> and downloading drivers for installation.

## Uninstalling

1. Select **App** → **Delete**, as shown in Figure 18.

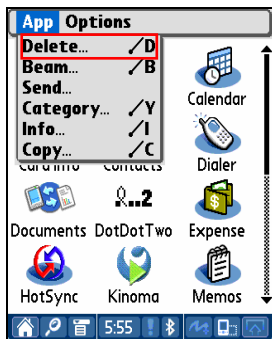
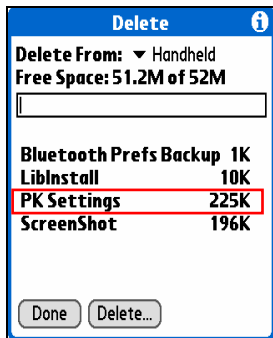

Figure 18. Uninstalling the Program

2. Select **PK Settings** and click **Delete...** , as shown in Figure 19. Delete the **PK Tutorial** using the same method.



**Figure 19. Deleting PK Settings**

### 5.2.3 Establishing a Connection with the Projection Keyboard

To establish a connection between a Palm device and the Projection Keyboard, please follow the instructions below.

1. Turn on the Palm device and the Projection Keyboard.

Note:

---

Check that sufficient battery power is supplied to the Projection Keyboard device.

---

2. Click the **PK Settings** icon to run the program, as shown in Figure 20.

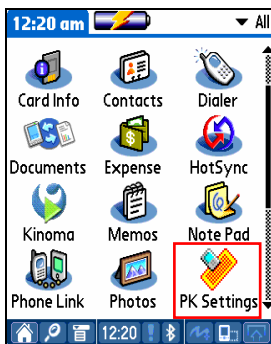

Figure 20. PK Settings Program

3. On the Palm Bluetooth device screen, select **Current Discovery** in the Show items, as shown in Figure 21.



**Figure 21. Showing Bluetooth Devices**



4. Select **CL800BT**, as shown in Figure 22.

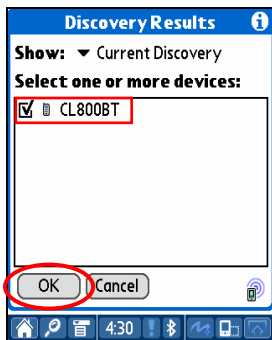

**Figure 22. Selecting CL800BT**

5. Click the **OK** button. The system will display a Connecting screen, as shown in Figure 23.

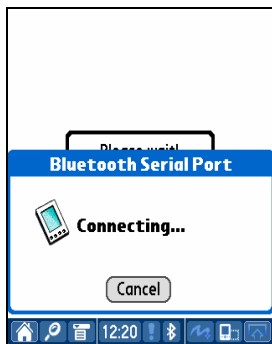

**Figure 23. Connecting to Bluetooth**

6. Once the Palm device and Projection Keyboard are connected, a tutorial screen is displayed, as shown in Figure 24.

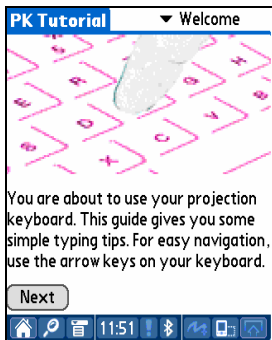

**Figure 24. Tutorial**

## 5.2.4 PK Settings

Once the Palm device and Projection Keyboard are connected, run the **PK Settings** program again to change the Projection Keyboard settings.

### 5.2.4.1 Main Screen

Select the Main screen to view Settings, as shown in Figure 25. You may set the following functions:

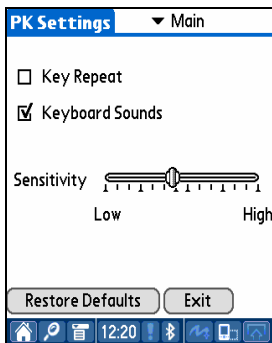

**Figure 25. Main Screen**

## **Key Repeat**

By using Key Repeat, continuously pressing a key causes the value to be entered repeatedly. Select the **Key Repeat** checkbox to use the key repeat function or deselect to disable the function.

## **Keyboard Sound**

Clicking the Keyboard Sound function causes a clicking sound to be emitted from the Pocket PC. Select the Keyboard Sound checkbox to turn on the key sound function or deselect it to disable the function.

## **Sensitivity**

If the Projection Keyboard has a problem with key sensitivity, adjust the setting using the slider.

For details, see “8. Adjusting Key Sensitivity”.

## **Restoring Defaults**

To restore all functions to their default values, click the Restore Defaults button.

## Disconnecting

To disconnect the Palm device from the Projection Keyboard, click on the **Exit** button.

### 5.2.4.2 Power Save Screen

In the Power Save menu, you can change settings related to power consumption, as shown in Figure 26.

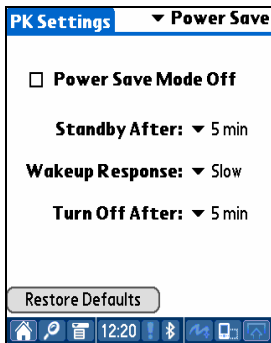

Figure 26. Power Save Mode

### **Power Save Mode**

Select the Power Save Mode Off checkbox to disable Power Save Mode, or deselect the checkbox to run Power Save Mode.

### **Standby Mode**

Change the Standby setting value to alter the time elapsed before the system enters Standby mode. In Standby mode, if no keys are pressed within a given period of time the device will enter a low power mode until a key is pressed again.

### **Wakeup Mode**

To use the keyboard again, press any key or area of the keyboard. Change the Wakeup Response settings to adjust the speed for switching between Standby and normal mode.

### **Power OFF Mode**

Once in Standby mode, if no keys are pressed within the time specified in the Turn Off After field, the device will enter Power OFF mode, as shown in Figure 13. To use the keyboard from Power OFF mode, turn the Projection Keyboard on again.

## Restoring Defaults

To restore the settings in the Power tab to their default values, click the **Restore Defaults** button.

### 5.2.4.3 Projector Screen

Adjust the brightness of the keyboard on the Projector menu, as shown in Figure 27.

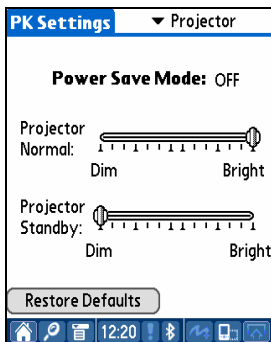

Figure 27. Projector Screen



### **Power Save Mode**

Shows whether the Power Save option is turned on or off.

### **Keyboard Brightness**

Change the Projector Normal slider to adjust the keyboard brightness.

### **Keyboard Brightness in Standby Mode**

Change the Projector Standby slider to adjust the keyboard brightness when in Standby mode.

### **Restoring Defaults**

To restore the settings to their default values, click the **Restore Defaults** button.

## 5.2.5 PK Tutorial

Click the **PK Tutorial** icon to launch the tutorial. You can view information on how to use the Projection Keyboard within the tutorial, as shown in Figure 28.

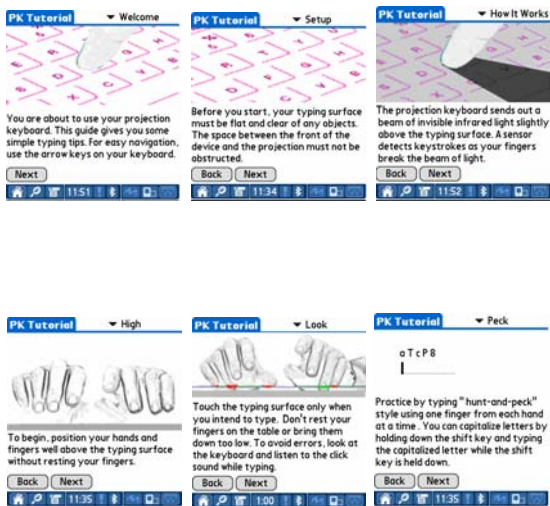











Figure 28. PK Tutorial

## 5.2.6 Shortcut Icon Keys

Table 2.1 shows the description for each icon.

Icon	Functions
	Switch to <b>Today</b> screen
	Run <b>To Do</b> program
	Run <b>Mail</b> program
	Run <b>Find</b> program
	Run <b>Web Browser</b>
	Run <b>Calculator</b> program
	Run <b>Calendar</b> program
	Run <b>Address</b> program

**Table 2.1 Icon Keys**

## 5.2.7 Shortcut Keys

Table 2.2.lists the FN and CTRL key combinations.

Key	Key Combination	Functions
FN	FN - 1	Run <b>Memo Pad</b> Program
	FN - 2	Run <b>Voice Memo</b> Program
	FN - F	<b>Select Font</b>
	FN - K	Launch <b>PK Settings</b> application
	FN - R	<b>Cmd + R</b>
	FN - Y	<b>Cmd + Y</b>
	FN - I	<b>Cmd + I</b>
	FN - D	<b>Cmd + D</b>
	FN - B	<b>Cmd + B</b>
	FN - N	<b>Cmd + N</b>
	FN - ←(left Arrow)	<b>Home</b>
	FN - →(Right Arrow)	<b>End</b>
	FN - ↑(Up Arrow)	<b>Page Up</b>

	FN - ↓ (Down Arrow)	<b>Page Down</b>
CTRL	CTRL - Z	<b>Undo</b>
	CTRL - X	<b>Cut</b>
	CTRL - V	<b>Paste</b>
	CTRL - C	<b>Copy</b>
	CTRL - A	<b>Select All</b>
	CTRL - U	<b>Undo</b>
	CTRL - S	<b>Select All</b>
	CTRL - F	<b>Find</b>
	CTRL - P	<b>Paste</b>

**Table 2.2 Key Combinations**

## 6. Keyboard Layout

Key layout of Projection Keyboard is as follows.



## 7. Typing Latin Letters and Additional Characters

FIRST	SECOND														Remark		
	A	E	I	O	U	Y	N	B	C	/	P	S	T	D		+	R
FN - '	SHIFT	Á	É	Í	Ó	Ú	Ý										
		á	é	í	ó	ú	ý										
FN - SHIFT - 6	SHIFT	Â	Ê	Î	Ô	Û											
		â	ê	î	ô	û											
FN - SHIFT - ;	SHIFT	Ă	Ě	Ī	Ö	Ü	Ÿ										
		ă	ě	ī	ö	ü	ÿ										
FN - `	SHIFT	À	È	Ì	Ò	Ù											
		à	è	ì	ò	ù											
FN - SHIFT - `	SHIFT	Ã			Õ		Ñ										
		ã			õ		ñ										
FN - O	SHIFT	Ä															
		ä															
FN - ,	SHIFT								Ç								
									ç								
FN - /	SHIFT				Ø												
					ø												
FN - E	SHIFT	Æ			Œ												
		æ			œ												
FN - S	SHIFT				¶												Symbol
					μ		β	©	¿	§	™	°	±	®			
FN - C		€			¥			¢		£							Currency



Key input e.g. 1) to input "Á" character:

Press FN key and ' key simultaneously.

Release both keys.

Press SHIFT and A simultaneously.

Key input e.g. 2) to input " ñ " character:

Press the FN key, SHIFT key and ` key simultaneously.

Release keys.

Press N.

Key input e.g. 3) to input "€" character:

Press FN key and C key simultaneously.

Release both keys.

Press E.

## 8. Adjusting Key Sensitivity

The Projection Keyboard determines key input based on the amount of light reflected from the finger. Since the perceived amount of light changes depending on the surrounding environment, key sensitivity should be set according to user-specific conditions.

### How to Adjust Key Sensitivity

1. Click Sensitivity on the settings screen.
2. Adjust the Sensitivity slider. Check if a key stroke is recognized by pressing the center of the space bar key.

### Key Sensitivity Setting Factors

Skin color

Thickness of fingers

Typing habit (leaning on keys)

Finger accessories (manicure etc.)

Surrounding environment

### **Caution**

- Key sensitivity must be adjusted each time a new user accesses the keyboard according to the new user's requirements.
- To ensure correct operation, avoid extreme light sources.
- Relevant environmental factors include:
  - Direct sunlight, artificial light, Infra Red Data Association (IrDA), remote control devices.

## **9. Safety Precautions**

**Never look directly at the light source.**

**Avoid direct sunlight or high levels of infrared rays.**

**Do not use in extreme brightness.**

**Do not use under very bright incandescent light.**

**Do not insert conductive material into the device, or damage the power or communication ports.**

**Do not strike or knock the device as this may cause damage or operational failure.**

**Do not disassemble the device. (After Sales Service will not be available)**

**Only use the cable/charging adapter supplied.**

**High pressure or heat may cause the lithium battery to explode.**

**Remove all objects on the surface between the device and the keyboard.**

**Use on a flat surface.**

**Avoid glass or transparent surfaces.**

**Fingers should not be positioned less than 5 mm from the surface.**

**Do not operate or store in high temperature or humidity.**

**Do not submerge in water.**

**It is not possible to get After Service for battery failure**

**caused by water. (Determined by color on the attached sticker.)**

## 10. Troubleshooting

### **The device will not turn on.**

Cause: Discharged battery.

Solution: Charge the battery fully.

### **Key strokes not recognized even though the keyboard is connected.**

Cause: Sensitivity set too low.

Solution: Reset to higher sensitivity and restart the device.

### **Keyboard image is not visible even though the keyboard operates.**

Cause:

1. When brightness is set low, standby or off
2. The device is not charged.

Solution:

1. Set brightness high, normal or on
2. Charge the device.

Cause: The device is overheated.

Solution: Move it to cooler surroundings and wait for a short time before restarting.

Cause: The device was not positioned on a flat surface.

Solution: Move to a flat surface.

**Incorrect keys are recognized when typing.**

Cause: Sensitivity is set too high.

Solution: Reset to lower sensitivity and restart the device.

Cause: The device was not positioned on a flat surface.

Solution: Move to a flat surface.

## 11. Specifications and Dimensions

### Keyboard Project

Items	Specifications
Light source	Red Laser diode
Keyboard layout	17mm QWERTY layout
Keyboard size	Approx. 241mm*106mm
Keyboard position	Approx. 100mm from keyboard device
Projection surface	Non-reflective, opaque flat surface
Visibility	Visible in 1000-5000 lux ambient light

### Keyboard Sensor

Items	Specifications
Illumination	Visible in incandescent light of 1800 lux or more
Detection rate	Up to 400 characters per minute
Effective key stroke	Approx. 2mm
Operating surface	Any flat surface



### Electrical Condition

Items	Specifications
Power source	Integral lithium battery
Battery capacity	830mAH(Max)@3.7V
Adapter	Rating 1A @ 5V
Interface	RS232C serial
Bluetooth	v1.1 class 2
Power consumption	Max. 3W@5V

### Environmental Condition

Items	Specifications
Operating temperature	Approx. 0~35°C
Storage temperature	Approx. -20~50°C

## **Compatible Operating Systems**

Microsoft Windows Mobile 2003

Palm OS 5.x

Microsoft Windows XP

**Size (mm):** 93 \* 39 \* 37.5

**Weight:** 109g

**For information on device and driver compatibility, please refer to <http://www.celluon.com>**

## **Technical Support:**

**Celluon, Inc.**

IT Venture Tower West 16F ,78 Garak-bondong,

Songpa-gu, Seoul, 138-803, Korea

**[support@celluon.com](mailto:support@celluon.com)**

**Tel.: +82-2-2142-1830**